



Service Data Tool for CO61,
BA21 and CO-LINK[™]
Data sheet

CO61, BA21 and CO-Link™

Service Data Tool ensures efficient maintenance of healthcare applications.

Service data tool enables easy read out of service data from the CO61, BA21 and CO-Link.

User friendly graphics gives easy understanding of data and shift between sections.

Efficient maintenance procedures is ensured by easy access to

- Knowledge about tear and wear
- Fault finding tool
- Easy service visit reports
- Service data



Features and Options:

- Read out service data on laptop via Service data tool
- Information about wear and tear helps ensure the application functionality at all times
- Actuator life time information is read out of the CO61 control box.
- Intelligent work counter sums up the work done by the actuators and considers how much the actuators have been loaded
- Overload information about why the application has stopped reduces number of service visits
- Easy service visit reports for documentation of service visit
- Keep updated service data also when replacing the control box or an actuator
- Trouble shooting section with error indication and log file to send for further technical support
- Help icon for easy data explanation
- Information icon e.g. for adding checklist for Service Technician to follow
- For mobile applications or applications with battery backup the BA21 Li-Ion battery section indicates battery Life and actual charging state
- Read out service data of up to 8 actuators with the CO-Link system connecting a primary and secondary CO61 and BA21







Usage:

- Compatible with CO61, BA21, CO-Link
- WIN 7 compatible

Service Data Tool user interface

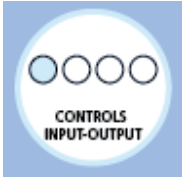
The Service data tool for CO61 is developed with focus on user friendly design which is easy to use.

Information is divided into sections as below:

SYMBOL	EXPLANATION
	For quick and easy overview of actuators info and fatal error status.
	For detailed information about the actuators' statistical service data. For refreshing data from the control unit connected. For update of information when replacing the actuator.
	For detailed information about hand control signals and codes.
	For service reporting, production number, software number, item number of the application. Saving complete relevant information for actuators data and service.
	Intended for trained or authorized service technicians only. For update of actuator info if the control is replaced to maintain service data. For update of information when replacing the actuator.
	For detailed information about errors on the actuator, control box or the controls. Easy download of log file to send for further technical support
	This section is only visible when CO61 is connected to LINAK BA21 lithium Ion battery. For indication of battery life, charging state and use.

Summary section:

For quick and easy overview of actuator statistics and fatal error status.

The screenshot displays the LINAK CO61 Service Data Tool interface. The main window is titled "LINAK CO61 Summary View v1.0". It features a sidebar on the left with connection information and device details. The central area is divided into sections for Battery, Actuator 1, Actuator 2, Actuator 3, and Actuator 4. Each actuator section provides a table of statistics including Status, Work, Overloads, Activations (IN and OUT), and Errors. A battery status indicator shows 89% charge. On the right, there are radio buttons for "Duty cycle guard" and "Current fatal error", a small image of the CO61 device, and a wheelchair icon. The bottom of the interface includes a navigation bar with icons for Summary, Actuator, Settings, and Battery, along with a "Company Logo" placeholder.

Connection Info:
 COM1 (100.17.1)
 OpenOK

Device Info:
 CO61
 LINAK Primary application
 Dr. No.: 13094024
 Version: 0.0071507
 Firmware:
 Type: 41
 Version: 1.4

BATTERY
 89%

ACTUATOR 1

Status	Work	Overloads	Activations		Errors
			IN	OUT	
IDLE	A · S	0	83	28	0

ACTUATOR 2

Status	Work	Overloads	Activations		Errors
			IN	OUT	
IDLE	A · S	0	125	37	0

ACTUATOR 3

Status	Work	Overloads	Activations		Errors
			IN	OUT	
IDLE	A · S	0	83	28	0

ACTUATOR 4

Status	Work	Overloads	Activations		Errors
			IN	OUT	
IDLE	A · S	0	125	36	0

Settings:
 Duty cycle guard
 Current fatal error

Footer:
 LINAK is not liable for any damage or accidents caused by misuse of Service Data Tool
 Reading Extended openbus device 1 register42

System example:

Service Data tool CO61, BA21 and 8 channels solution:

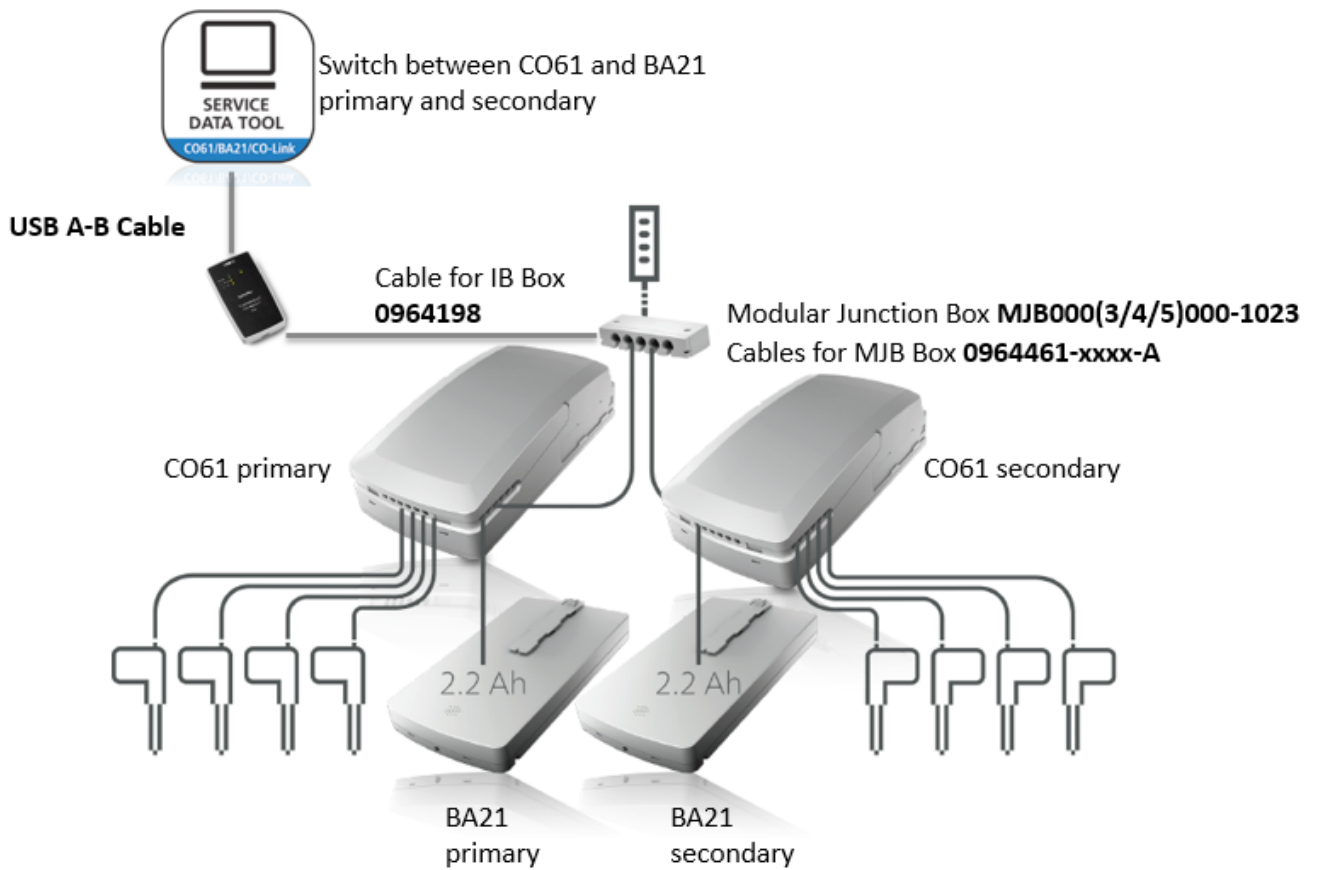

Notice! The service data tool can also be used for CO61 combined with the lead-acid battery BA19.

Please remember to order cables, the modular junction box and the IB300001 box for data read-out from CO61 to laptop.

Article number	Product
IB300001	Box for data read out from CO61 primary or CO61 secondary to laptop
MJB000 (3/4/5) 000-1023	Modular Junction box for connection of Service data tool and footswitch, hand control or other OpenBus accessories
0964198	Cable for usage of service data tool (from MJB to IB300001 box)
0964461-xxxx-A SML912497-A	Cable for connection of MJB to CO61: Straight, RAL 7035, Modular Jack, RAL7035, Modular jack, length xxx mm Splitter mains cable for CO61 primary and CO61 secondary

Terms of use

The user is responsible for determining the suitability of LINAK products for specific application. LINAK takes great care in providing accurate and up-to-date information on its products.

However, due to continuous development in order to improve its products, LINAK products are subject to frequent modifications and changes without prior notice. Therefore, LINAK cannot guarantee the correct and actual status of said information on its products.

While LINAK uses its best efforts to fulfill orders, LINAK cannot, for the same reasons as mentioned above, guarantee the availability of any particular product. Therefore, LINAK reserves the right to discontinue the sale of any product displayed on its website or listed in its catalogues or other written material drawn up by LINAK.

All sales are subject to the Standard Terms of Sale and Delivery for LINAK. For a copy hereof, please contact LINAK.